

TECHNICAL SHEET / SCHEDA TECNICA



Proccopio

P6 Xs Glycol system



TEKNEITALIA[®]

The Art of Quality



GELATO



MEASURES/MISURE



FIG. 1

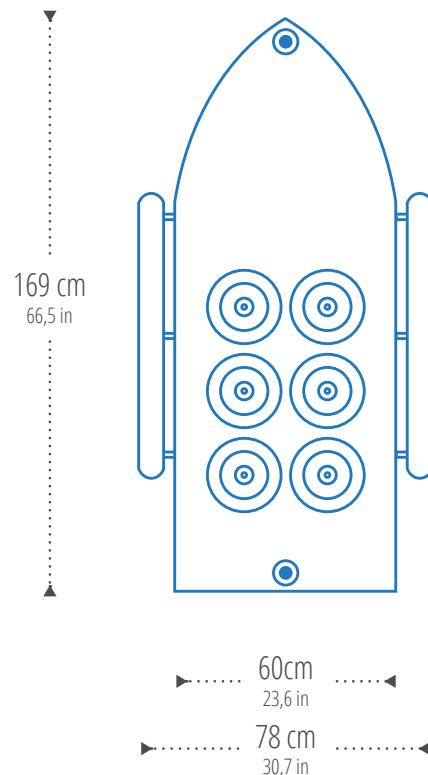



FIG. 2

TECHNICAL SPECIFICATIONS

CERTIFICATION

| |  |  |
|--|---|---|
| EMPTY WEIGHT KG | about 250 | 250 circa |
| LOAD CAPACITY | 6+6 Stainless steel tubs (5kg each) total 60kg | 6+6 carapine (5kg cad.) totale 60kg |
| OPERATING COLD ROOM TEMPERATURE | -25°/+5°C, -13°/+41° F | -25°/+5°C |
| CLIMATE CLASS | from 0° to 35°C | da 0° a 35°C |
| COLD AUTONOMY | 6/7 hours | 6/7 ore |
| BODY | Painted aluminium | Alluminio verniciato |
| OVERLAY | Telescopic and removable tent in stainless steel | Tenda telescopica e smontabile in acciaio INOX |
| LIGHTING | Removable LED light in stainless steel | Plafoniera smontabile LED in acciaio INOX |
| WORKTOP | Stainless steel | Acciaio INOX |
| POWER SUPPLY | 240V/50Hz or 110V/60Hz | 240V/50Hz oppure 110V/60Hz |
| POWER CONSUMPTION | 450W | 450W |

Subject to technical modifications

Mezzo soggetto a modifiche tecniche



Glycol system



Models

Cooling System



Injected polyurethane without HCFC/CFC
Glycol refrigeration
Condensing hermetic system with motor fan,
temperature control, copper evaporator
-25°/+5°C
from 0° to 35°C
6/7 hours



PROCOPIO P6
PROCOPIO P8
PROCOPIO P3 SLIM
PROCOPIO P4 SLIM
PROCOPIO P4 XSLIM
PROCOPIO P3 XSLIM
DON COLA IN
DON COLA FX
DON GIOVANNI
GEA IN
ERMES

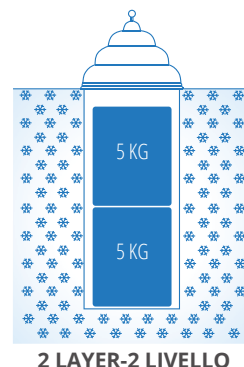

Poliuretano iniettato senza HCFC/CFC
Refrigerazione a Glicole
Sistema condensante ermetico con motoventilatore,
controllo della temperatura, evaporatore in rame
-25°/+5°C
da 0° a 35°C
6/7 ore



KATERINA P6
KATERINA P8
KATERINA P4 SLIM
KATERINA P6 SLIM
DON COLA OUT
GEA OUT
ERMES

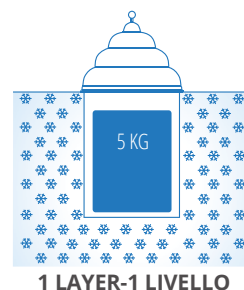

Dry convective system



Models



Injected polyurethane without HCFC/CFC
Dry refrigeration
Condensing hermetic system with motor fan,
temperature control, copper evaporator
-25°/+5°C
from 0° to 35°C
30 min



PROCOPIO V6
PROCOPIO V9

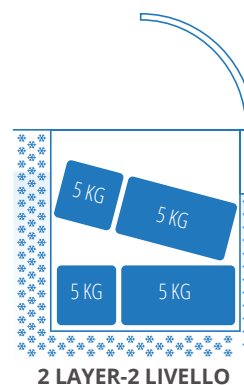

Poliuretano iniettato senza HCFC/CFC
Refrigerazione a secco
Sistema condensante ermetico con motoventilatore,
controllo della temperatura, evaporatore in rame
-25°/+5°C
da 0° a 35°C
30 min



KATERINA V6
KATERINA V6 SLIM

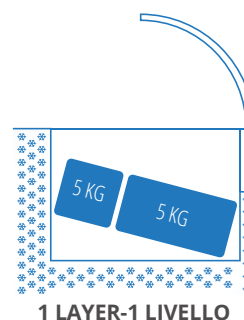



Procoppio

Detachable bike system



Katerina

Detachable bike system



TEKNĒITALIA[®]

The Art of Quality



GELATO

