

TECHNICAL SHEET / SCHEDA TECNICA



# Katerina

P8 Glycol system



**TEKNEITALIA**<sup>®</sup>

The Art of Quality



GELATO



## P8 Glycol system

### MEASURES/MISURE



FIG. 1

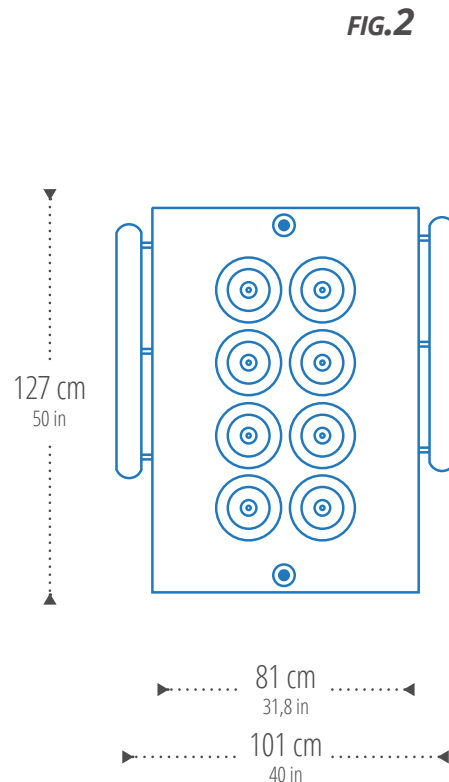



FIG. 2

### TECHNICAL SPECIFICATIONS

#### CERTIFICATION

		
<b>EMPTY WEIGHT KG</b>	about 260	260 circa
<b>LOAD CAPACITY</b>	8 Stainless steel tubs (5kg each) total 40kg	8 carapine (5kg cad.) totale 40kg
<b>OPERATING COLD ROOM TEMPERATURE</b>	-25°/+5°C, -13°/+41° F	-25°/+5°C
<b>CLIMATE CLASS</b>	from 0° to 35°C	da 0° a 35°C
<b>COLD AUTONOMY</b>	4/5 hours	4/5 ore
<b>BODY</b>	Painted aluminium	Alluminio verniciato
<b>OVERLAY</b>	Telescopic and removable tent in stainless steel	Tenda telescopica e smontabile in acciaio INOX
<b>LIGHTING</b>	Removable LED light in stainless steel	Plafoniera smontabile LED in acciaio INOX
<b>WORKTOP</b>	Stainless steel	Acciaio INOX
<b>POWER SUPPLY</b>	240V/50Hz or 110V/60Hz	240V/50Hz oppure 110V/60Hz
<b>POWER CONSUMPTION</b>	350W	350W

Subject to technical modifications

Mezzo soggetto a modifiche tecniche



Glycol system



Models

Cooling System



Injected polyurethane without HCFC/CFC  
Glycol refrigeration  
Condensing hermetic system with motor fan,  
temperature control, copper evaporator  
-25°/+5°C  
from 0° to 35°C  
6/7 hours



PROCOPIO P6  
PROCOPIO P8  
PROCOPIO P3 SLIM  
PROCOPIO P4 SLIM  
PROCOPIO P4 XSLIM  
PROCOPIO P3 XSLIM  
DON COLA IN  
DON COLA FX  
DON GIOVANNI  
GEA IN  
ERMES

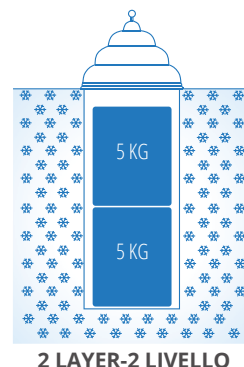

Poliuretano iniettato senza HCFC/CFC  
Refrigerazione a Glicole  
Sistema condensante ermetico con motoventilatore,  
controllo della temperatura, evaporatore in rame  
-25°/+5°C  
da 0° a 35°C  
6/7 ore



KATERINA P6  
KATERINA P8  
KATERINA P4 SLIM  
KATERINA P6 SLIM  
DON COLA OUT  
GEA OUT  
ERMES

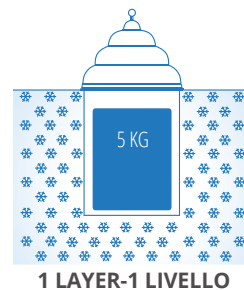

Dry convective system



Models



Injected polyurethane without HCFC/CFC  
Dry refrigeration  
Condensing hermetic system with motor fan,  
temperature control, copper evaporator  
-25°/+5°C  
from 0° to 35°C  
30 min



PROCOPIO V6  
PROCOPIO V9

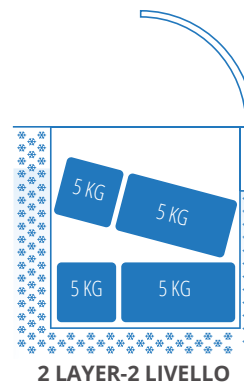

Poliuretano iniettato senza HCFC/CFC  
Refrigerazione a secco  
Sistema condensante ermetico con motoventilatore,  
controllo della temperatura, evaporatore in rame  
-25°/+5°C  
da 0° a 35°C  
30 min



KATERINA V6  
KATERINA V6 SLIM

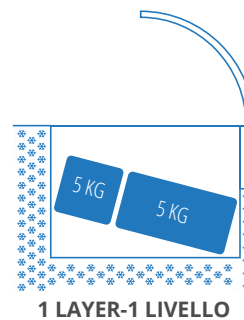

TECHNICAL SHEET / SCHEDA TECNICA



# Procoppio

Detachable bike system



# Katerina

Detachable bike system



**TEKNĒITALIA**®

The Art of Quality



GELATO

