

TECHNICAL SHEET / SCHEDA TECNICA



# Proccopio

P4 SLIM Glycol system



**TEKNEITALIA®**

The Art of Quality



GELATO



# Procopio

TECHNICAL SHEET  
rev. 001/01102019

CODE 1329

**P4 SLIM Glycol system**

## MEASURES/MISURE



FIG. 1

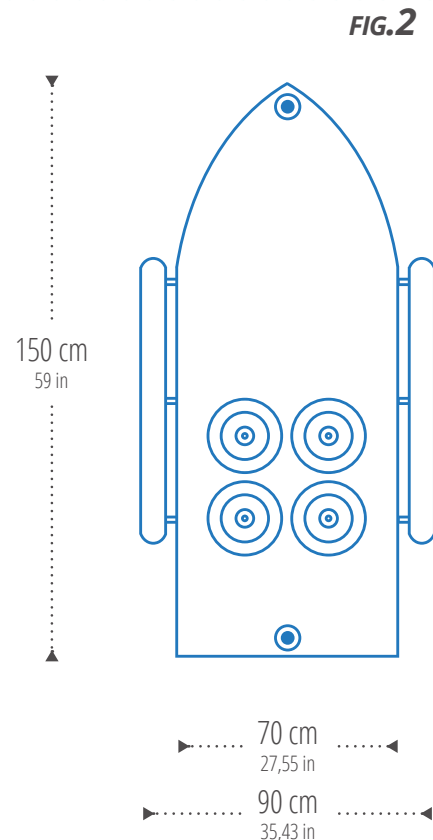



FIG. 2

## TECHNICAL SPECIFICATIONS

### CERTIFICATION

		
<b>EMPTY WEIGHT KG</b>	about 280	280 circa
<b>LOAD CAPACITY</b>	4+4 Stainless steel tubs (5kg each) total 40kg	4+4 carapine (5kg cad.) totale 40kg
<b>OPERATING COLD ROOM TEMPERATURE</b>	-25°/+5°C, -13°/+41° F	-25°/+5°C
<b>CLIMATE CLASS</b>	from 0° to 35°C	da 0° a 35°C
<b>COLD AUTONOMY</b>	6/7 hours	6/7 ore
<b>BODY</b>	Painted aluminium	Alluminio verniciato
<b>OVERLAY</b>	Telescopic and removable tent in stainless steel	Tenda telescopica e smontabile in acciaio INOX
<b>LIGHTING</b>	Removable LED light in stainless steel	Plafoniera smontabile LED in acciaio INOX
<b>WORKTOP</b>	Stainless Steel	Acciaio INOX
<b>POWER SUPPLY</b>	40V/50Hz or 110V/60Hz	240V/50Hz oppure 110V/60Hz
<b>POWER CONSUMPTION</b>	450W	450W

Subject to technical modifications

Mezzo soggetto a modifiche tecniche



**TEKNĒITALIA®**

**Glycol system**



**Models**

**Cooling System**



Injected polyurethane without HCFC/CFC  
Glycol refrigeration  
Condensing hermetic system with motor fan,  
temperature control, copper evaporator  
-25°/+5°C  
from 0° to 35°C  
6/7 hours



**PROCOPIO P6**  
**PROCOPIO P8**  
**PROCOPIO P3 SLIM**  
**PROCOPIO P4 SLIM**  
**PROCOPIO P4 XSLIM**  
**PROCOPIO P3 XSLIM**  
**DON COLA IN**  
**DON COLA FX**  
**DON GIOVANNI**  
**GEA IN**  
**ERMES**

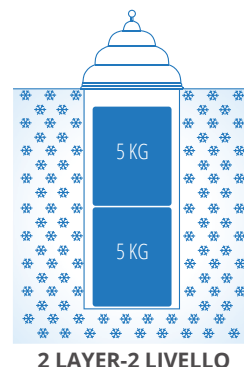

Poliuretano iniettato senza HCFC/CFC  
Refrigerazione a Glicole  
Sistema condensante ermetico con motoventilatore,  
controllo della temperatura, evaporatore in rame  
-25°/+5°C  
da 0° a 35°C  
6/7 ore



**KATERINA P6**  
**KATERINA P8**  
**KATERINA P4 SLIM**  
**KATERINA P6 SLIM**  
**DON COLA OUT**  
**GEA OUT**  
**ERMES**

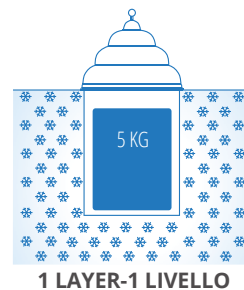

**Dry convective system**



**Models**



Injected polyurethane without HCFC/CFC  
Dry refrigeration  
Condensing hermetic system with motor fan,  
temperature control, copper evaporator  
-25°/+5°C  
from 0° to 35°C  
30 min



**PROCOPIO V6**  
**PROCOPIO V9**

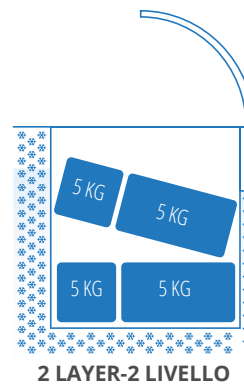

Poliuretano iniettato senza HCFC/CFC  
Refrigerazione a secco  
Sistema condensante ermetico con motoventilatore,  
controllo della temperatura, evaporatore in rame  
-25°/+5°C  
da 0° a 35°C  
30 min



**KATERINA V6**  
**KATERINA V6 SLIM**

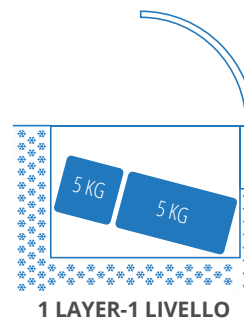

TECHNICAL SHEET / SCHEDA TECNICA



# Procoppio

Detachable bike system



# Katerina

Detachable bike system



**TEKNĒITALIA**<sup>®</sup>  
The Art of Quality

