

TECHNICAL SHEET / SCHEDA TECNICA



# Proccopio

P3 SLIM Glycol system



**TEKNEITALIA**<sup>®</sup>

The Art of Quality



GELATO



## MEASURES/MISURE



FIG. 1

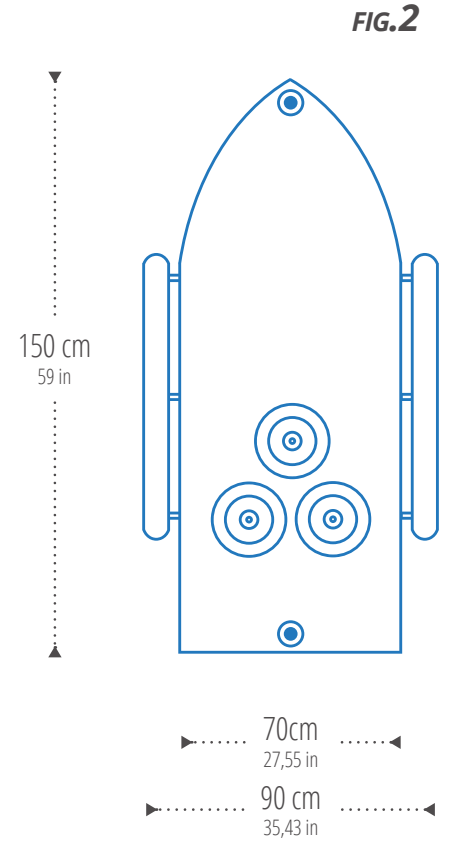



FIG. 2

## TECHNICAL SPECIFICATIONS

### CERTIFICATION

		
<b>EMPTY WEIGHT KG</b>	about 250	250 circa
<b>LOAD CAPACITY</b>	3+3 Stainless steel tubs (5kg each) total 30kg	3+3 carapine (5kg cad.) totale 30kg
<b>OPERATING COLD ROOM TEMPERATURE</b>	-25°/+5°C, -13°/+41° F	-25°/+5°C
<b>CLIMATE CLASS</b>	from 0° to 35°C	da 0° a 35°C
<b>COLD AUTONOMY</b>	6/7 hours	6/7 ore
<b>BODY</b>	Painted aluminium	Alluminio verniciato
<b>OVERLAY</b>	Telescopic and removable tent in stainless steel	Tenda telescopica e smontabile in acciaio INOX
<b>LIGHTING</b>	Removable LED light in stainless steel	Plafoniera smontabile LED in acciaio INOX
<b>WORKTOP</b>	Stainless steel	Acciaio INOX
<b>POWER SUPPLY</b>	240V/50Hz or 110V/60Hz	240V/50Hz oppure 110V/60Hz
<b>POWER CONSUMPTION</b>	450W	450W

Subject to technical modifications

Mezzo soggetto a modifiche tecniche



**Glycol system**



**Models**

**Cooling System**



Injected polyurethane without HCFC/CFC  
Glycol refrigeration  
Condensing hermetic system with motor fan,  
temperature control, copper evaporator  
-25°/+5°C  
from 0° to 35°C  
6/7 hours



**PROCOPIO P6  
PROCOPIO P8  
PROCOPIO P3 SLIM  
PROCOPIO P4 SLIM  
PROCOPIO P4 XSLIM  
PROCOPIO P3 XSLIM  
DON COLA IN  
DON COLA FX  
DON GIOVANNI  
GEA IN  
ERMES**

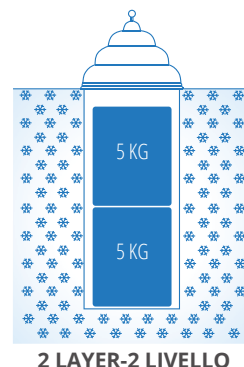

Poliuretano iniettato senza HCFC/CFC  
Refrigerazione a Glicole  
Sistema condensante ermetico con motoventilatore,  
controllo della temperatura, evaporatore in rame  
-25°/+5°C  
da 0° a 35°C  
6/7 ore



**KATERINA P6  
KATERINA P8  
KATERINA P4 SLIM  
KATERINA P6 SLIM  
DON COLA OUT  
GEA OUT  
ERMES**

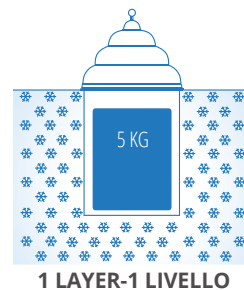

**Dry convective system**



**Models**



Injected polyurethane without HCFC/CFC  
Dry refrigeration  
Condensing hermetic system with motor fan,  
temperature control, copper evaporator  
-25°/+5°C  
from 0° to 35°C  
30 min



**PROCOPIO V6  
PROCOPIO V9**

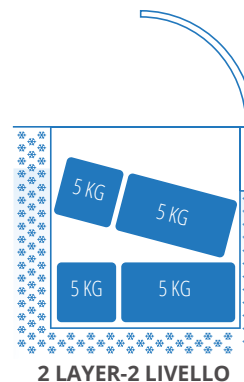

Poliuretano iniettato senza HCFC/CFC  
Refrigerazione a secco  
Sistema condensante ermetico con motoventilatore,  
controllo della temperatura, evaporatore in rame  
-25°/+5°C  
da 0° a 35°C  
30 min



**KATERINA V6  
KATERINA V6 SLIM**

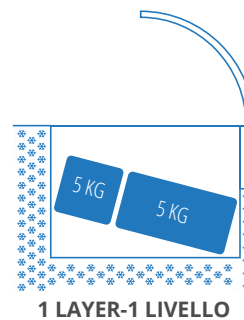

TECHNICAL SHEET / SCHEDA TECNICA



# Procoppio

Detachable bike system



# Katerina

Detachable bike system



**TEKNĒITALIA**<sup>®</sup>  
The Art of Quality

